

# ASSEMBLY INSTRUCTION

FOR C8311A/C8321A/B81138A/B8337A CHEST, DRESSER, & NIGHT STAND

## STEP 1

Pull the drawer and take out the Bunfoot carton ( A ).

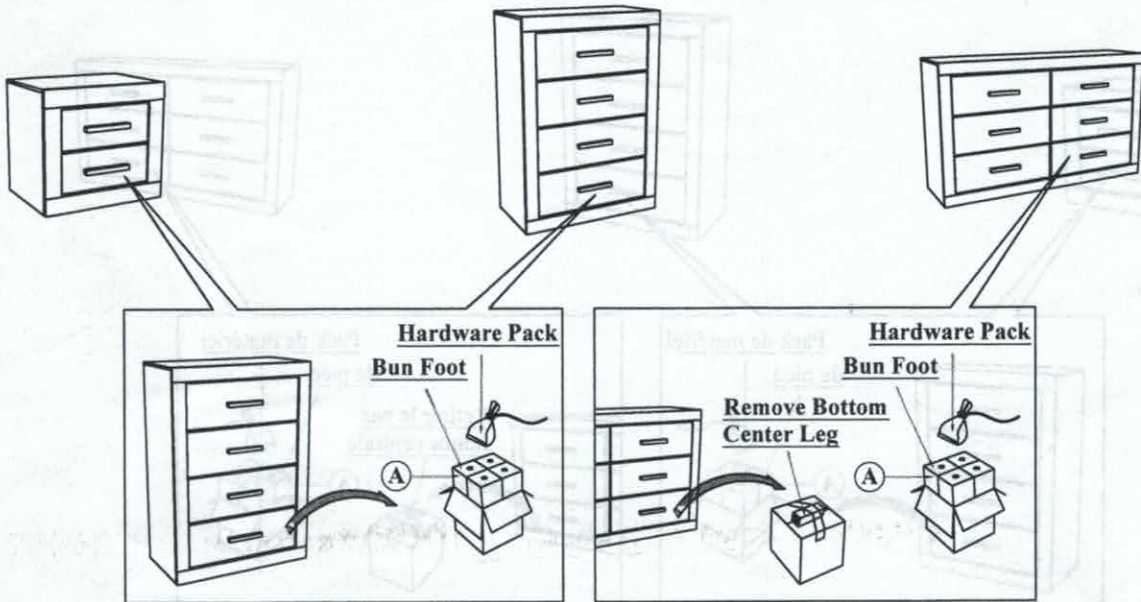

## STEP 2

Assemble the Bun Foot (A) with JCBC Bolt (1), Spring washer (2), Flatwasher (3) and securing with Allen Key (4) as shown.

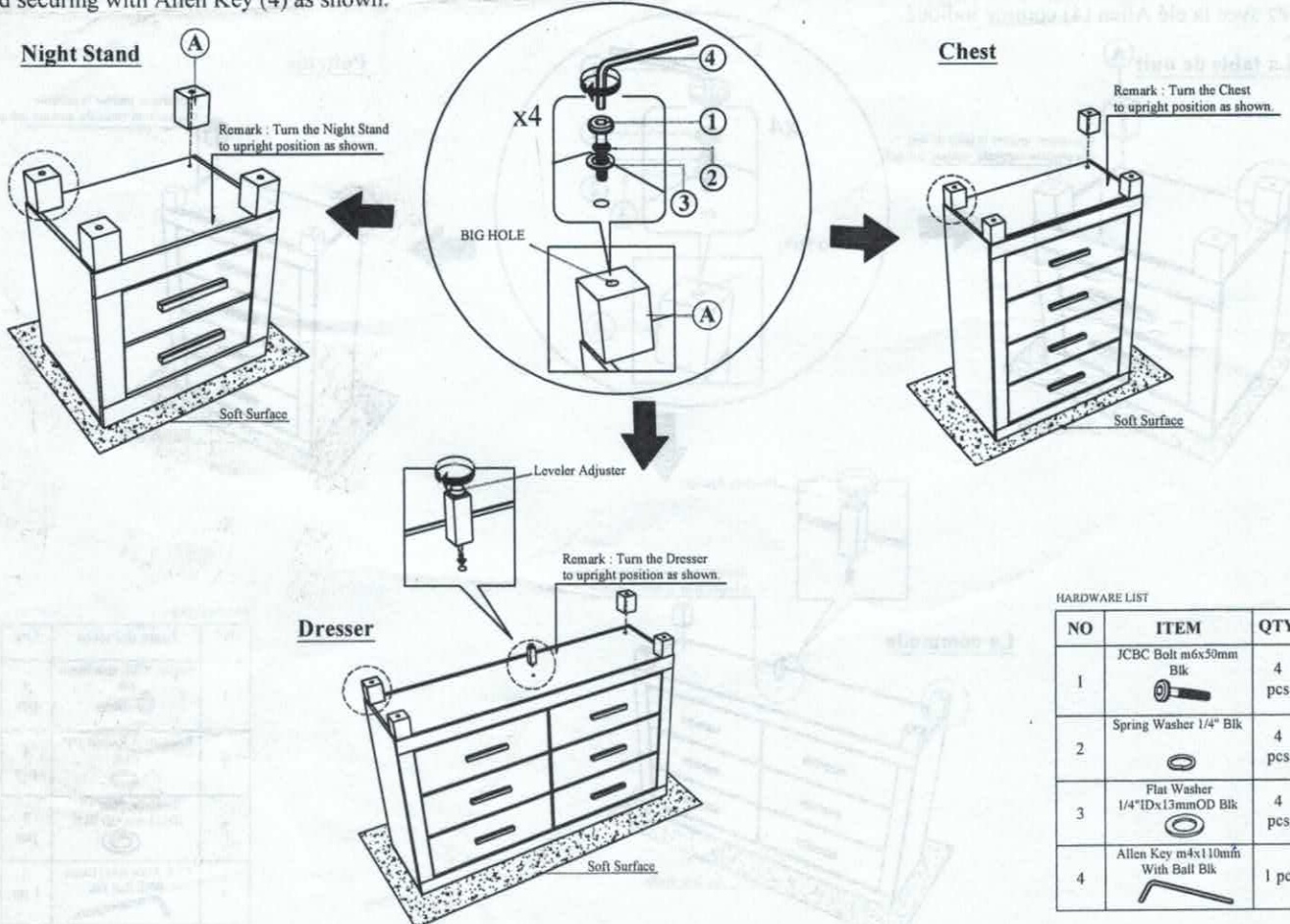

### HARDWARE LIST

NO	ITEM	QTY
1	JCBC Bolt m6x30mm Blk	4 pcs
2	Spring Washer 1/4" Blk	4 pcs
3	Flat Washer 1/4"IDx13mmOD Blk	4 pcs
4	Allen Key m4x110mm With Ball Blk	1 pc